

Key Data

3 x 375A AC at 690V AC, aircooled, switching frequency max 1000Hz

General Information

Stack with IGBT, heatsinks, capacitors, drivers and sensors for several inverter applications. These are only technical data! Please read heedful the complete documentation and attend the adopted design environment! Especially the EMC environment and the controller functionality.

Topology	DC Link + B6I	
Load Type	Resistive, inductive load	
Cooling	Forced air, fan excluded	
Targed Application	Industrial Drive	
Extra	Available in Master [M] and Slave [S] configuration	
Drivercore	Scale Driver	
Monitors	Current-, Voltage-, Temperature-Monitoring	
Module (Unit1)		n.a.
Module (Unit2)	IGBT	3x FF800R17KF6C
Interface	Electrical, opt. Optical	
Standards	EN50178, UL94, prepared for UL508C	
Product ID (eupec)	24125	
Drawing No.	38000015_M_MB	
Circuit Diagram No.	57000002	

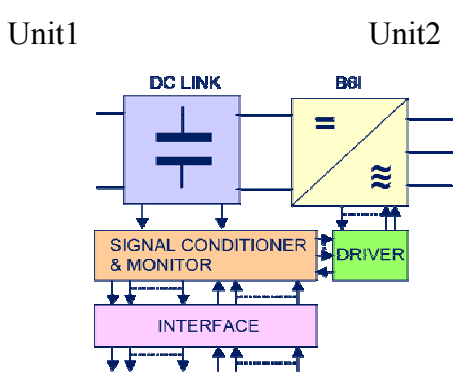

The diagram illustrates the internal components of the ModSTACK units. Unit1 contains a DC LINK (represented by a capacitor symbol) and Unit2 contains a B6I (represented by a diagonal line with a wavy line). Both units are connected to a central SIGNAL CONDITIONER & MONITOR (orange box) and a DRIVER (green box). These components are then connected to an INTERFACE (pink box) which has multiple bidirectional connections.

Electrical Data

	Parameter		Min	Typ	Max	
Assumed Linevoltage	For Isolation-Management	Vline		690		VRMS
DC Link Voltage		VDC		975	1219	Vav
DC Link Overvoltage Shutdown	Within 100µs			VDCmax		V
DC Link Current		IDCLink		460		Aav
Voltage Unit1		Vunit1		-		V
Continuous Current Unit1	$\vartheta = \vartheta_{air_inlet}$	IUnit1		-		A
Shorttime Current Unit1	10s, every 180s, initial load = IUnit1	IUnit1_10		-		A
Pulse Current Unit1	Sinehalfwave 20ms				-	Apeak
DC Current at Unit1	No rotating field, $\vartheta = \vartheta_{air_inlet}$,	IUnit1_DC			-	Aav

Overcurrent Shutdown Unit1	Percentage of IUnit1. Within 15µs			-		%
Switching Freq. Unit1		fsw1		-		Hz
Power Losses Unit1	V=Vunit1_min, I=IUnit1, fsw=fsw1	Ploss1		-		W
Voltage Unit2	Depending on Controller	Vunit2		690		VRMS
Displacement factor		cos_φUnit2	-1		+1	
Continious Current Unit2	ϑ=ϑair_inlet, ϑchip ≤ 125°C fUnit2>5Hz	IUnit2			375	ARMS
Shorttime Current Unit2	ϑair_inlet≤40°C, 10s, every 180s, initial load = IUnit2	IUnit2_60			450	ARMS
Pulse Current Unit2	Sinehalfwave 20ms				-	Apeak
DC Current at Unit2	No rotating field, ϑ=ϑair_inlet,	IUnit2_DC			0,4* IUnit2	ADC
Overcurrent Shutdown Unit2	Percentage of IUnit2. Within 15µs			125		%
Switching Freq. Unit2		fsw2			1000	Hz
Power Losses Unit2	I=IUnit2, fsw=fsw2	Ploss2		3260		W
Power Losses (PCB and Capacitor)		Ploss_aux			350	W
Auxiliary Voltage		Vaux	18	24	30	Vav
Auxiliary Power Demand	Vaux=24 Vav, to feed with B6U	Paux		40		W
EMC Test	According EN61800-3 at named interfaces	Power	VBurst		2	kV
		Control	VBurst		1	
		Aux (24V)	VSurge		1	kV
Insulation Test Voltage	According EN50178 f=50Hz, t=1min	Visol		1,8		kVRMS

Important Component Data

DC Link Capacitor		CDC		11		mF
DC Link Capacitor		Type		Electrolyt		
Capacitor Design Lifetime (eupec approximation)	Loadcycle: Wind	LTD		-		Year
	Loadcycle: Solar	LTD		-		Year
	Loadcycle for: Industrial Drive (ϑair=35°C, I=0,8, Duration=24h/Day)	LTD		20		Year

Requirements to the Powersource

Assumed Inductance Of Feeding Powersource	(Necessary inductance not included, feeded by B6U)	LFeed		135		μH
---	--	-------	--	-----	--	---------------

Fan Data (assumed when excluded)

Fan Type	Assumed		RF22			
Fan Voltage		VFan		230		VRMS
Fan Frequency		fFan		50		Hz
Fan Current		IFan		1,31		ARMS
Fan Air Pressure	Assumed	Δp_{AirFan}		250		Pa

Controller Interface Data

Driver	See Datasheet	PCB	TR101			
Paralleling Interface	See Datasheet	PCB	-			
Optical Interface	See Datasheet	PCB	optionally OEA101			
Digital Input Level	Resistor to Gnd (1,8k) High = on min 15mA	Vin	0		15	V
Digital Output Level	Open collector Low = ok max 15mA	Vout	0		15	V
Analog Current Outputs Unit1	Load max 1mA At IUnit1			-		V
Analog Current Outputs Unit2	Load max 1mA At IUnit2			4		V
Analog DC Link Voltage Output	Load max 1 mA At VDCmax	VDCout		9		V
Analog Temperature Out	Load max 1mA At $\vartheta_j=125^\circ\text{C}$	V ϑ_{out}		9		V
Optical Input Level	optionally		12			μW
Optical Output Level	optionally				60	μW

Requirements to the Controller

EMC Protection	According EN61800-3 at auxiliary power and controlinterface		1			kV
EMC Enviroment			Shieldconcept with TE (True Earth) separated from PE, HF conform installation			
Drive Pulse Time		ton_min	10			μs
Blockout Time		tpause	10			μs
Overvoltage Shut Down Reaction Time	After overvoltage message by PowerSTACK Interface				50	μs

Overcurrent Shut Down Reaction Time	After overcurrent message by PowerSTACK Interface				10	μs
-------------------------------------	---	--	--	--	----	---------------

Mechanical Data

Airvelocity	$\vartheta_{\text{Air}}=20^{\circ}\text{C}$ $p_{\text{Air}}=1013\text{ hPa}$ Dry- and dustfree, measured outside of heatsink. According DIN 41882	v_{Air}	7			m/s
Airflow heatsink		dV/dt_{Air}	800			m^3/h
Air Pressure Drop heatsink		Δp_{Air}		250		
Watervelocity	According Coolingwater Specification from eupec	v_{Water}				m/s
Waterflow heatsink		dV/dt_{Water}	-			m^3/h
Water Pressure Drop heatsink		Δp_{Water}		-		
Dimensions	Width x Depth x Hight		702	540	304	mm
Mass	Approximation			45		kg
Storage Temperature Range		ϑ_{stor}	-40		+65	$^{\circ}\text{C}$
Operating Temperature range (PCB and Capacitor)	Minimal 0°C for optional optical interface	ϑ_{op}	-25 (0)		+55	$^{\circ}\text{C}$
Cooling Air Inlet Temperature (Heatsink)		$\vartheta_{\text{air_inlet}}$	-25		+40	$^{\circ}\text{C}$
Cooling Airvelocity (PCB and Capacitor)		$v_{\text{Air_PCB}}$	2			m/s
Air Pressure	Standard atmosphere	p_{Air}	900		1100	hPa
Humidity	No Condensation	Rel. F	0		95	%
Installation Height			0		1000	m
Vibration	EN60068-2-6, Fc 10..59Hz 0,075mm				10	m/s^2
Permanence Vibration	EN60068-2-6, Fc 10-150Hz, 20 Cycles				20	m/s^2
Shock	EN60068-2-27, Ea Halfsine 11ms, 3 pulses				100	m/s^2
Protection Degree			IP00			
Pollution Degree			2			
Overvoltage Category			III			

Derating Curves (IGBT Part)

Current derating at low rotating field frequency (f_0). **Maximal 100% current is allowed.**

$\cos(\phi) = 0.64$, (motor)
 $\Theta_{air} = 40^\circ\text{C}$

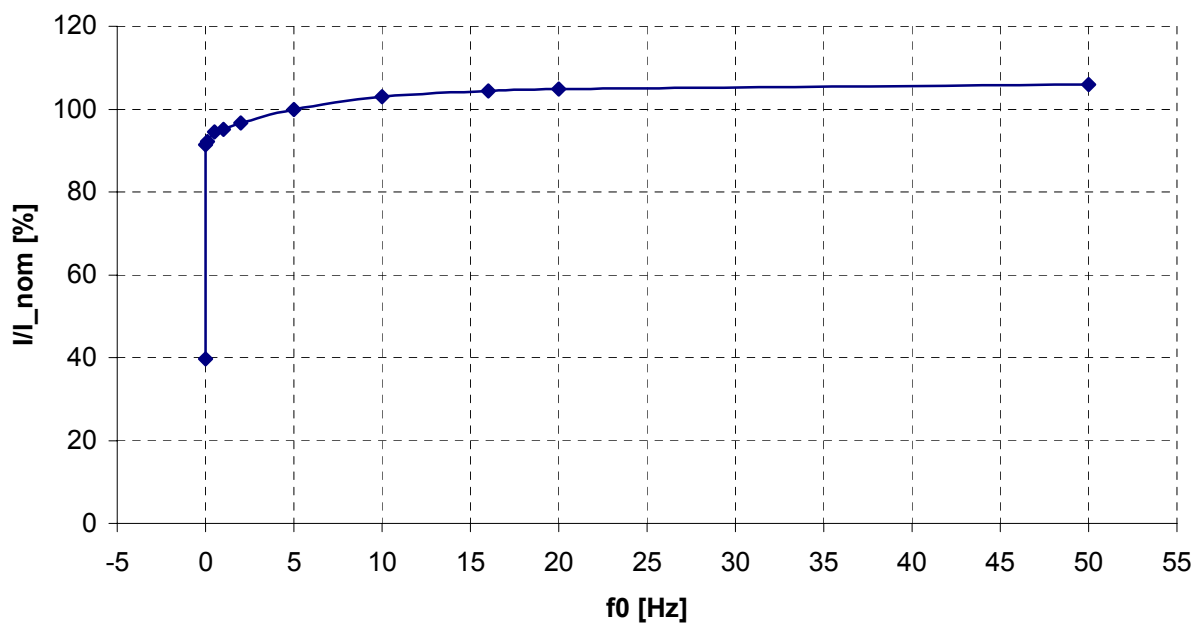

$\cos(\phi) = -0.64$, (generator)
 $\Theta_{air} = 40^\circ\text{C}$

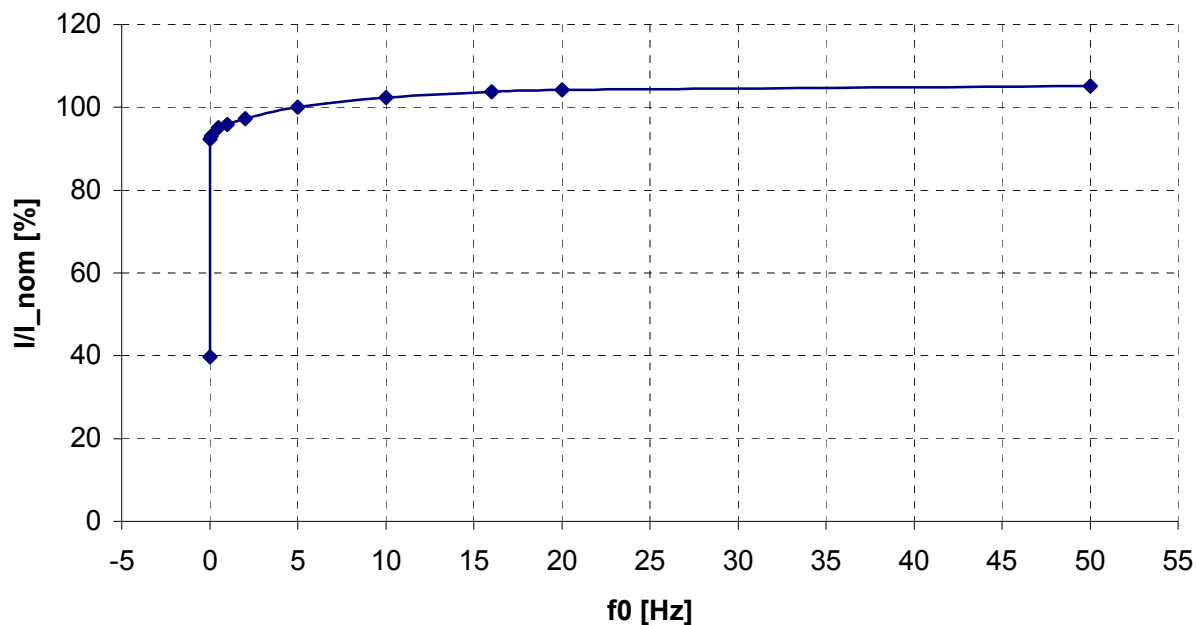

Current derating at different switching frequencies. See datatable for nominal switching frequency. In this general drawing 2500Hz ist assumed. **Maximal 100% current is allowed.**

**IGBT, $\cos(\phi) = 0.64$
Theta_{air} = 40°C**

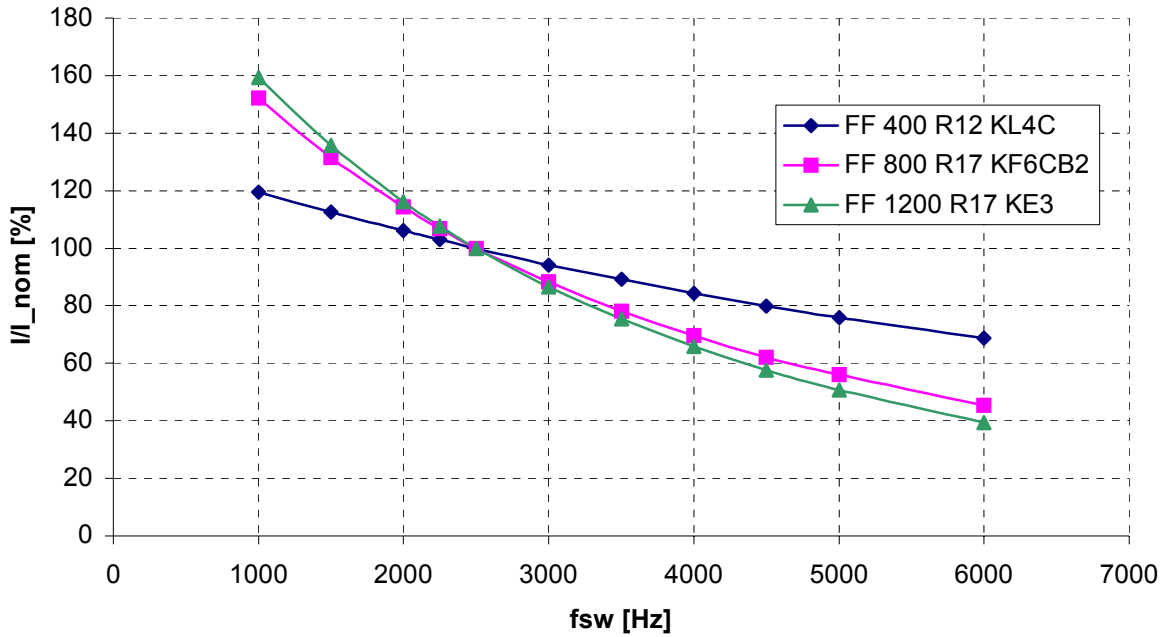

**Diode, $\cos(\phi) = 0.64$
Theta_{air} = 40°C**

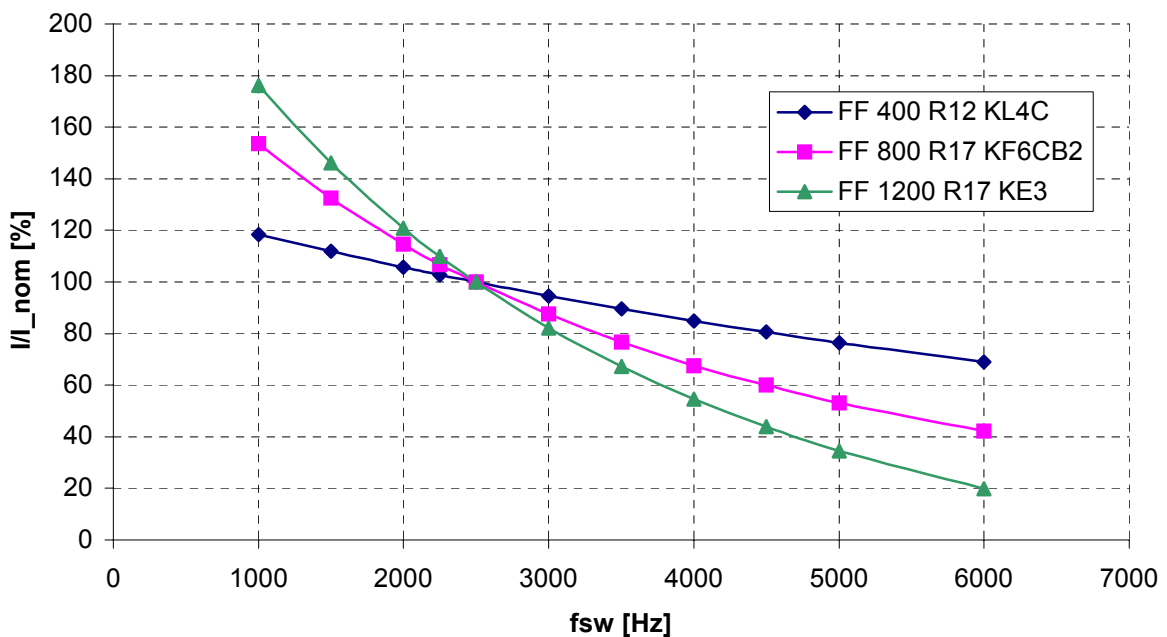

IGBT, $\cos(\phi) = -0.64$
 $\Theta_{air} = 40^{\circ}\text{C}$

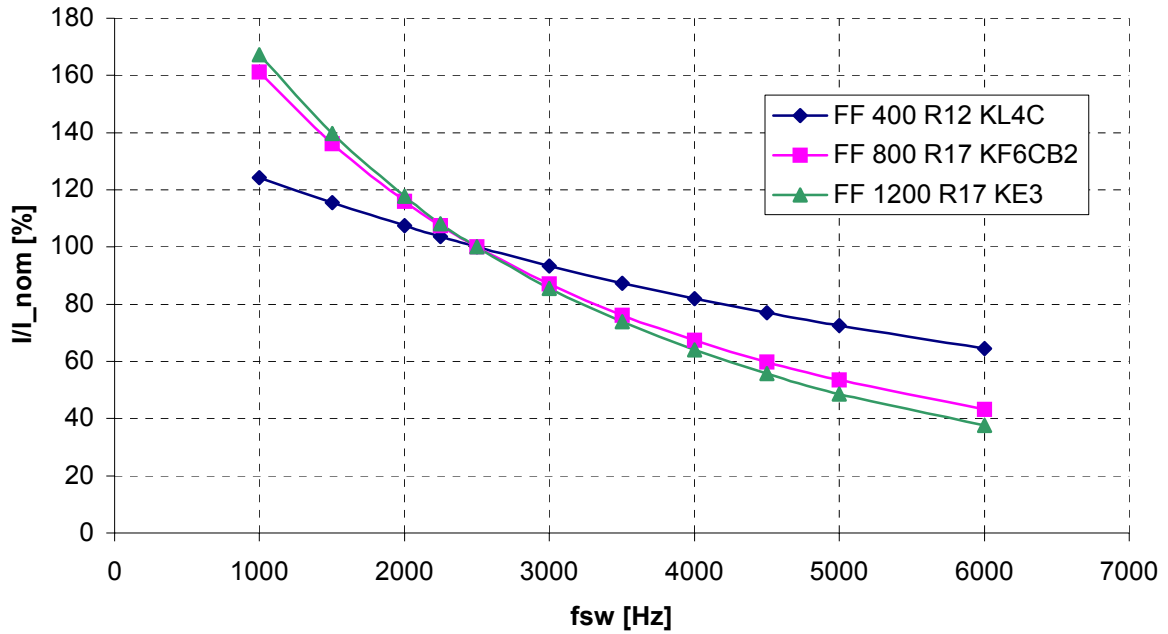

Diode, $\cos(\phi) = -0.64$
 $\Theta_{air} = 40^{\circ}\text{C}$

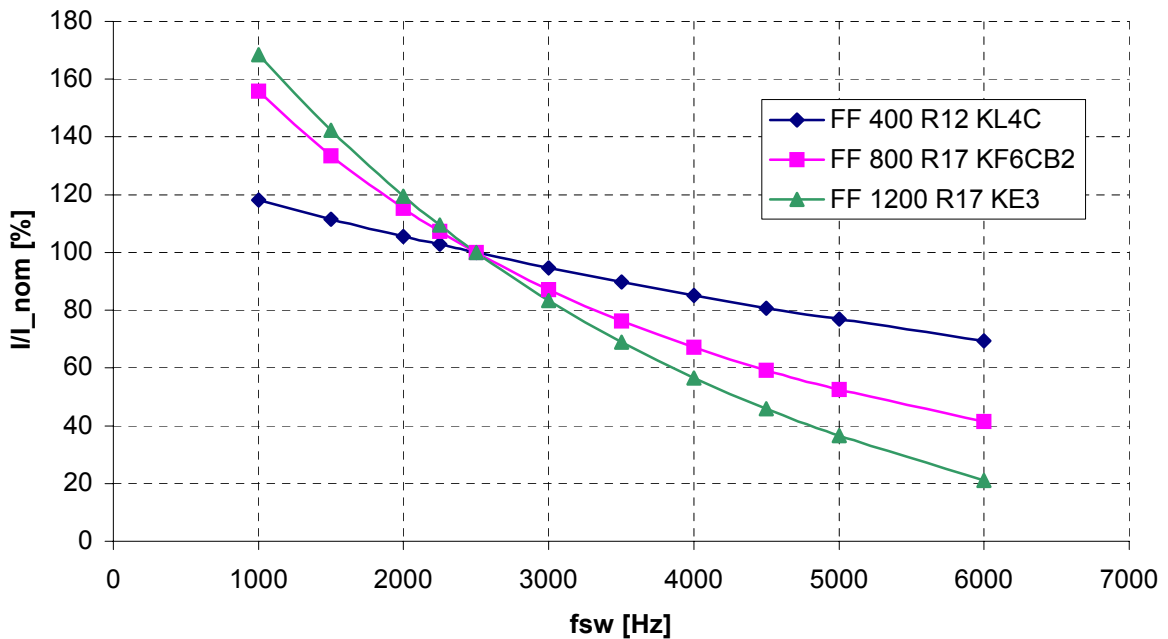

Miscellaneous

This technical information specifies semiconductor stacks but promises no characteristics. It is valid in combination with the belonging technical notes.

This document may be changed without prior notice.

Warning!

Prior to installation and commissioning all safety notices and warnings and all warning signs attached to the equipment have to be carefully read. Make sure that all warning signs remain in a legible condition and missing or damaged signs are replaced.

The safety instructions have to be strictly adhered to.

The manual contains detailed information on all technical topics with regard to the eupec ModSTACK. For further details regarding publications of the eupec ModSTACK and information on other publications in the area of ModSTACKs please contact your nearest eupec branch or visit our website: <http://www.eupec.com>.

©eupec GmbH 2005. All rights reserved

Prepared by	J.Schiele	2003-03-31	Date of publication	
Approved by	H.Nübel	2003-03-31	Revision	0.3, 27.9.2005

ModSTACK B6I 690/1100-375G M, S, Drawing, Preliminary Data

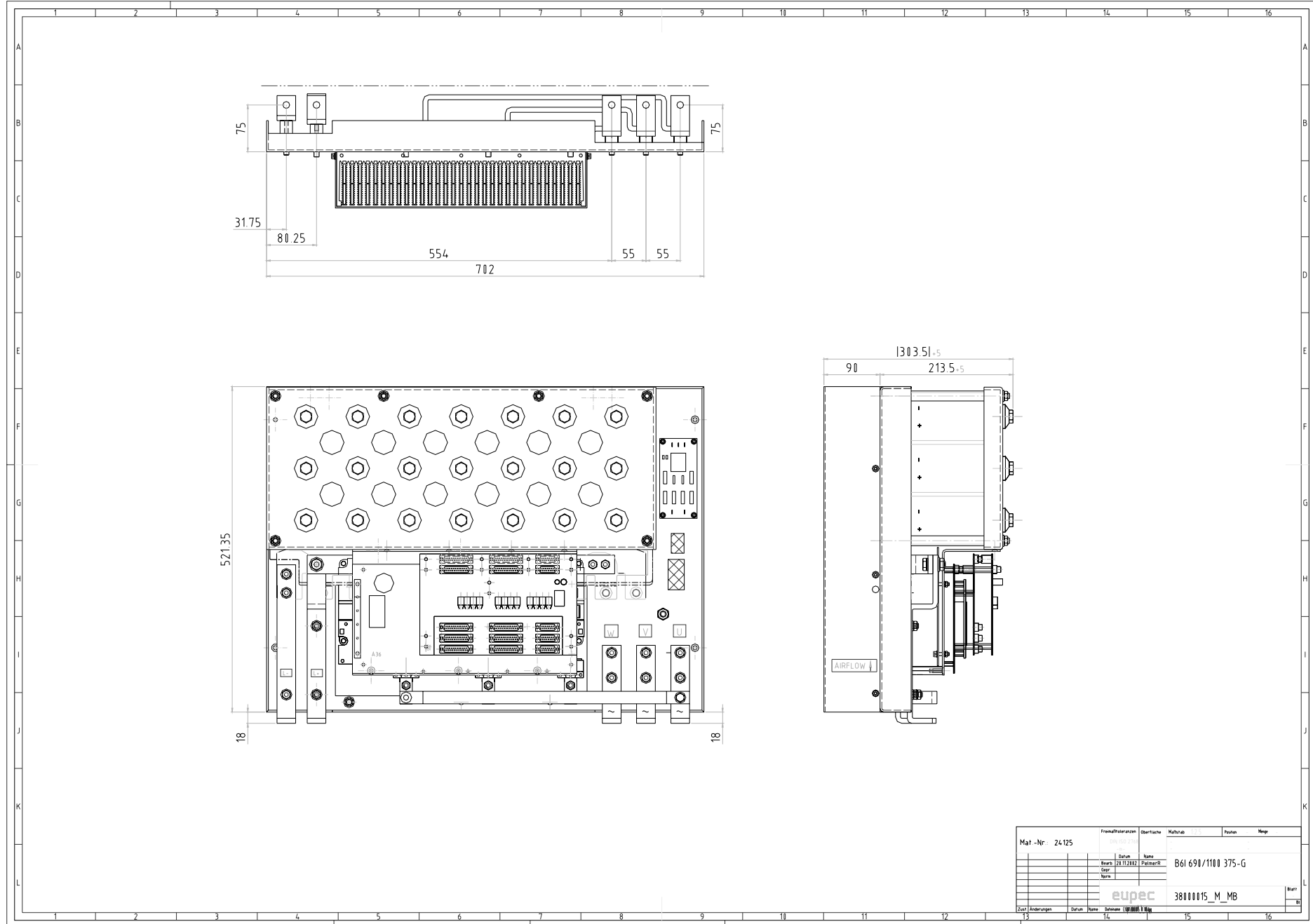

Mat-Nr.	24125	Fremdreferenzen	Druckseite	Multibak	Position	Maßstab
		Druck	Name	B6I 690/1100 375-G		
		Start	22.01.2012	PalmerR		
		Exp.				
		Rev.				
				eupec	38000015_M_MB	Blatt
						14
Zust.	Änderungen	Druck	Name	Schreiber	14	